

DVD Video Player Owner's Manual



Let's make things better.



PHILIPS

Important Note

DK

Advarsel:

Laserrudstråling ved åbning når sikkerhesafbrydere er ude af funktion. Undgå u tsættelse for stråling.

Bemærk:

Netafbryderen POWER er sekundært indkoblet og afbryder ikke strømmen fra nettet. Den indbyggede netdel er derfor tilsluttet til lysnettet så længe netstikket sidder i stikkontakten.

N

Observer:

Nettbryteren POWER er sekundært innkoplet. Den innebygdenetdelen er derfor ikke frakoplet nettet så lenge apparatet er tilsluttet nettkontakten.

This product incorporates copyright protection technology that is protected by method claims of certain U.S. patents and other intellectual property rights owned by Macrovision Corporation and other rights owners. Use of this copyright protection technology must be authorized by Macrovision Corporation, and is intended for home and other limited viewing uses only unless otherwise authorized by Macrovision Corporation. Reverse engineering or disassembly is prohibited.

S

Klass 1 laserapparat

Varning!

Om apparaten används på annat sätt än i denna bruksanvisning specificerats, kann användaren utsättas för laserstrålning, som översjrunder gränsen för läserklass 1.

Observera!

Strömbrytaren POWER är sekundärt kopplad och inte bryter strömmen fråan nätet Den inbyggda nätdelen är därför ansluten till elnätet så länge stickproppen sitter i v ägguttaget.

SF

Luokan 1 laserlaite + Klass 1 laserapparat

Varoitus!

Laitteen käyttäminen muulla kuin tässä käyttöohjeessa mainitulla tavalla saattaa altistaa käyttäjän turvallisuusluokan 1 ylittävälle lasersäleille.

Huom.

Toiminnanvalitsin POWER on kytketty toisiopuolelle, eikä se kytke laitetta irti sähköverkosta. Sisäänrakennettu verkko-osa on kytkettynä sähköverkkoon aina silloin, kun pistoke on pistorasiasassa.

Manufactured under license from Dolby Laboratories. "Dolby" and the double-D symbol are trademarks of Dolby Laboratories. Confidential Unpublished Works. © 1992 - 1997 Dolby Laboratories, Inc. All rights reserved.

Important Note for Users in the UK

Mains plug

This apparatus is fitted with an approved 13 Amp plug. To change a fuse in this type of plug proceed as follows:

- 1 Remove fuse cover and fuse.
- 2 Fix new fuse which should be a BS1362 5 Amp, A.S.T.A. or BSI approved type.
- 3 Refit the fuse cover.

If the fitted plug is not suitable for your socket outlets, it should be cut off and an appropriate plug fitted in its place.

If the mains plug contains a fuse, this should have a value of 5 Amp. If a plug without a fuse is used, the fuse at the distribution board should not be greater than 5 Amp.

Note: The severed plug must be disposed of to avoid a possible shock hazard should it be inserted into a 13 Amp socket elsewhere.

How to connect a plug

The wires in the mains lead are coloured with the following code: blue = neutral (N), brown = live (L).

As these colours may not correspond with the colour markings identifying the terminals in your plug, proceed as follows:

- Connect the blue wire to the terminal marked N or coloured black.
- Connect the brown wire to the terminal marked L or coloured red.
- Do not connect either wire to the earth terminal in the plug, marked E (or e) or coloured green (or green and yellow).

Before replacing the plug cover, make certain that the cord grip is clamped over the sheath of the lead - not simply over the two wires.

Copyright in the U.K.

Recording and playback of material may require consent. See Copyright Act 1956 and The Performer's Protection Acts 1958 to 1972.

Index

English ----- 5

English

Français ----- 27

Français

Deutsch ----- 49

Deutsch

Español ----- 71

Español

Italiano ----- 93

Italiano

Português ----- 115

Português

Ελληνικά ----- 137

Ελληνικά

Polski ----- 159

Polski

Turkish ----- 181

Turkish

General Information

Laser safety

This unit employs a laser. Due to possible eye injury, only a qualified service person should remove the cover or attempt to service this device.

USE OF CONTROLS OR ADJUSTMENTS OR PERFORMANCE OF PROCEDURES OTHER THAN THOSE SPECIFIED HEREIN MAY RESULT IN HAZARDOUS RADIATION EXPOSURE.

LASER

Type	Semiconductor laser GaAlAs
Wave length	650 nm (DVD) 780 nm (VCD/CD)
Output Power	7 mW (DVD) 10 mW (VCD/CD)
Beam divergence	60 degree

CAUTION

VISIBLE AND INVISIBLE LASER RADIATION WHEN OPEN AVOID EXPOSURE TO BEAM

ADVARSEL

SYNLIG OG USYNLIG LASERSTRÅLING VED ÅBNING UNDGÅ UDSÆTTELSE FOR STRÅLING

VARNING

SYNLIG OCH OSYNLIG LASERSTRÅLNING NÄR DENNA DEL ÄR ÖPPNAD BETRAKTA EJ STRÅLEN

VARO!

AVATTAESSA OLET ALTTIINA NÄKYVÄLLE JA NÄKYMÄTTÖMÄLLE LASER SÄTEILYLLE. ÄLÄ KATSO SÄTEESEEN

VORSICHT

SICHTBARE UND UNSICHTBARE LASERSTRAHLUNG WENN ABDECKUNG GEÖFFNET NICHT DEM STRAHL AUSSETZEN

ATTENTION

RAYONNEMENT LASER VISIBLE ET INVISIBLE EN CAS D'OUVERTURE EXPOSITION DANGEREUSE AU FAISCEAU

TruSurround and the SRS symbol are trademarks of SRS Labs., Inc. TruSurround technology is manufactured under license from SRS Labs., Inc.

TruSurround™
by **SRS** (●)®

For Customer Use:

Read carefully the information located at the bottom of your DVD Video player and enter below the Serial No. Retain this information for future reference.

Model No. DVD VIDEO Q40

Serial No. _____

The region code for this DVD Video Player is 2.



Since DVD movies are released at different times in different regions of the world, all players have region codes and discs can have an optional region code. If you load a disc of a different region code into your player, you will see the region code notice on the screen. The disc will not play and should be unloaded.

NOTE:
PICTURES SHOWN MAY BE DIFFERENT BETWEEN COUNTRIES.

NEVER MAKE OR CHANGE CONNECTIONS WITH THE POWER SWITCHED ON.

CAUTION
VISIBLE AND INVISIBLE RADIATION WHEN OPEN AVOID EXPOSURE TO BEAM (WARNING LOCATION: ON THE BACKPLATE OF SET)

"As an Energy Star® partner, Philips has determined that this product meets the Energy Star® guidelines for energy efficiency"



CE The DVDVIDEO player is in conformity with the EMC directive and low-voltage directive.

"DTS" and "DTS DIGITAL SURROUND" are registered trademarks of Digital Theater Systems, Inc.

Introduction

Philips DVD Video Introduction	6
Unpacking	6
Remote Control Battery Installation	6
Environmental Information	6
Safety Information	6
Cleaning Discs	6

Functional Overview

Front and Rear Panels	7
Remote Control	8

Preparation

General Notes	9
Connecting to a TV	9
Connecting to Optional Equipment	10
NTSC/PAL Settings	11
NTSC/PAL Conversion	11
General Explanation	11
Initial Setup (Virgin Mode)	12
Display on Front Panel	12
Menu Bar on TV Screen	13
Temporary Feedback Field Icons	13
Personal Preferences	13-15

Operation

Loading Discs	16
Playing a DVD Video and Video CD	16
General Features	16-18
Special DVD Features	19
Special Video CD & SVCD Features	19
Playing an Audio CD	19-20
Favorite Track Selection (FTS) Program	20
MP3 Disc Features	21

Access Control

Access Control: Child Lock	22
Access Control: Parental Control	22-23

Before Requesting Service

Before Requesting Service	24
---------------------------------	----

Appendix

Speaker Settings	25
------------------------	----

Specifications

Specifications	26
----------------------	----

Philips DVD Video Introduction

Your Philips DVD Video player will play digital video discs conforming to the universal DVD Video standard. The unique features on DVD Video, such as selection of sound track, subtitle languages and different camera angles (again depending on the disc), are all supported. In addition to DVD Video discs, you will be able to play all Video CDs and Audio CDs.

DVD Video

You will recognize DVD Video discs by the logo shown. Depending on the material on the disc (a movie, video clips, a drama series, etc.) the disc may have one or more Titles.

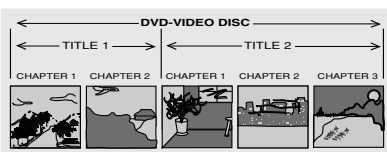

Video CD

You will recognize Video CDs by the logo shown.



Super Video CD (SVCD)

SVCDs are based on the Super-VCD IO Standard, referring to the Standard of Electronics Industry of the People's Republic of China.

Audio CD

Audio CDs contain music tracks only. You will recognize Audio CDs by the logo shown.



MP3 (MPEG Audio Layer 3)

This player supports the MP3 format which contains compressed music tracks.

Note:

- Only the first session of multisession discs is supported.

Unpacking

First check and identify the contents of your DVD Video player package.

You should have the following items.

- DVD Video player
- AC power cord
- Remote Control with batteries
- Audio cable
- CVBS Video cable
- SCART cable
- Instructions for use

If any item is damaged or missing, contact your retailer or Philips.

Keep the packaging material for future transportation.

Remote Control Battery Installation

- Insert batteries as indicated inside the battery compartment.

Caution: Do not mix old and new batteries. Never mix different types of batteries (standard, alkaline, etc.).

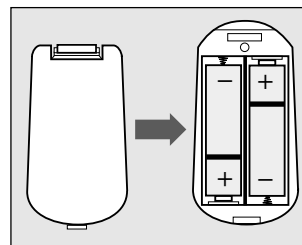

Environmental Information

- Your system consists of materials that can be recycled and reused if disassembled by a specialized company. Please observe the local regulations regarding the disposal of packaging materials, exhausted batteries and old equipment.

Safety Information

- Do not expose the system to excessive moisture, rain, sand, or heat sources.
- Place the player on a firm, flat surface.
- Keep the player away from domestic heating equipment and direct sunlight.
- In a cabinet, allow about 2.5 cm (1 inch) of free space all around the player for adequate ventilation.
- If the DVD Video player cannot read CDs/DVDs correctly, use a commonly available cleaning CD/DVD to clean the lens before taking the DVD Video player to be repaired. Other cleaning methods may destroy the lens. Always keep the tray closed to avoid dust on the lens.
- The lens may cloud over when the DVD Video player is suddenly moved from cold to warm surroundings. Playing a CD/DVD is not possible then. Leave the power on for about one hour with no disc in the unit until normal playback is possible.

Cleaning Discs

- When a disc becomes dirty, clean it with a cleaning cloth. Wipe the disc from the center out, in a straight line.
- Do not use solvents such as benzine, thinner, commercially available cleaners, or anti-static spray intended for analog discs.

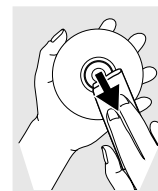

Functional Overview

Front and Rear Panels

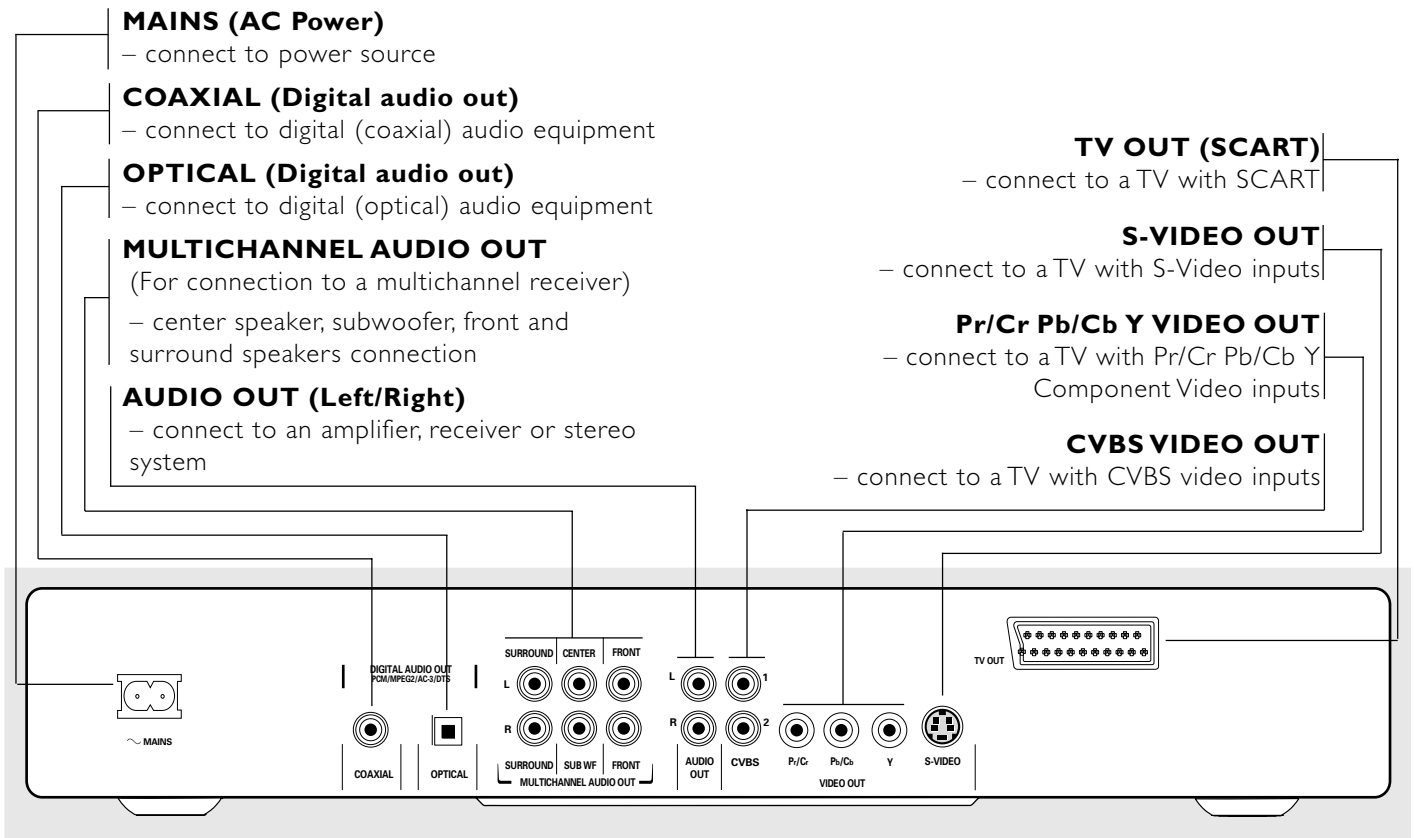
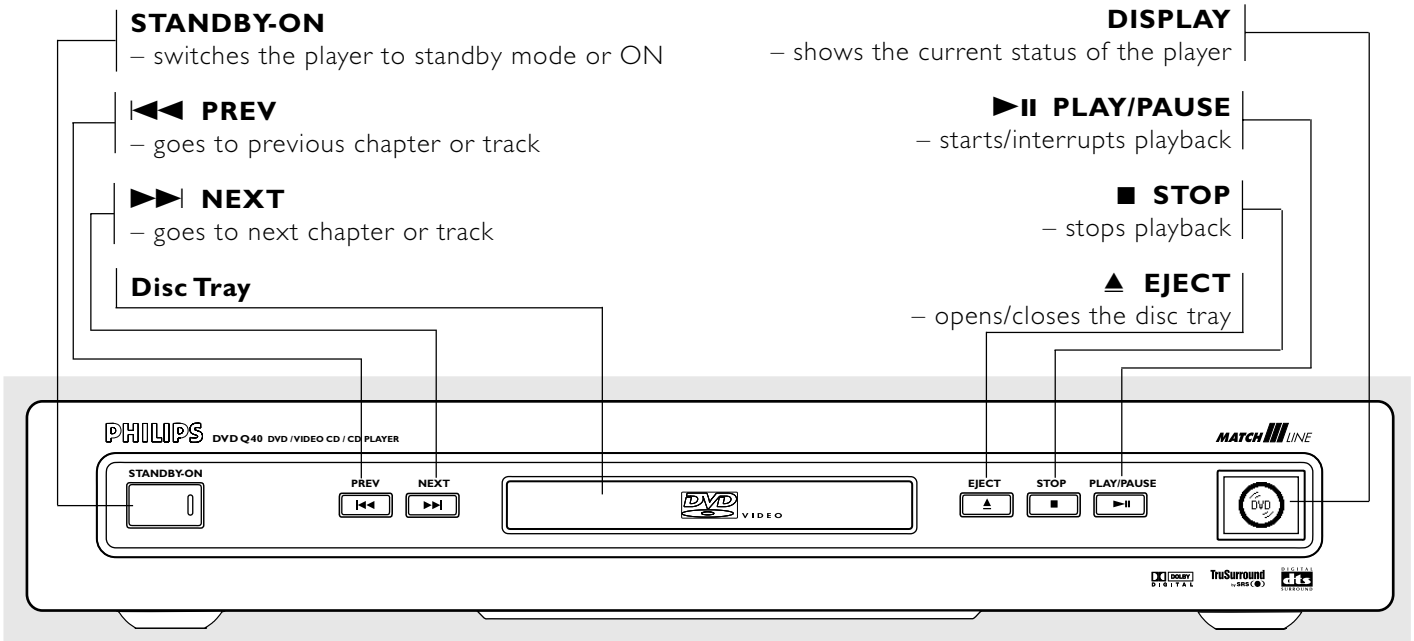

Caution: Do not touch the inner pins of the jacks on the rear panel. Electrostatic discharge may cause permanent damage to the unit.

Remote Control

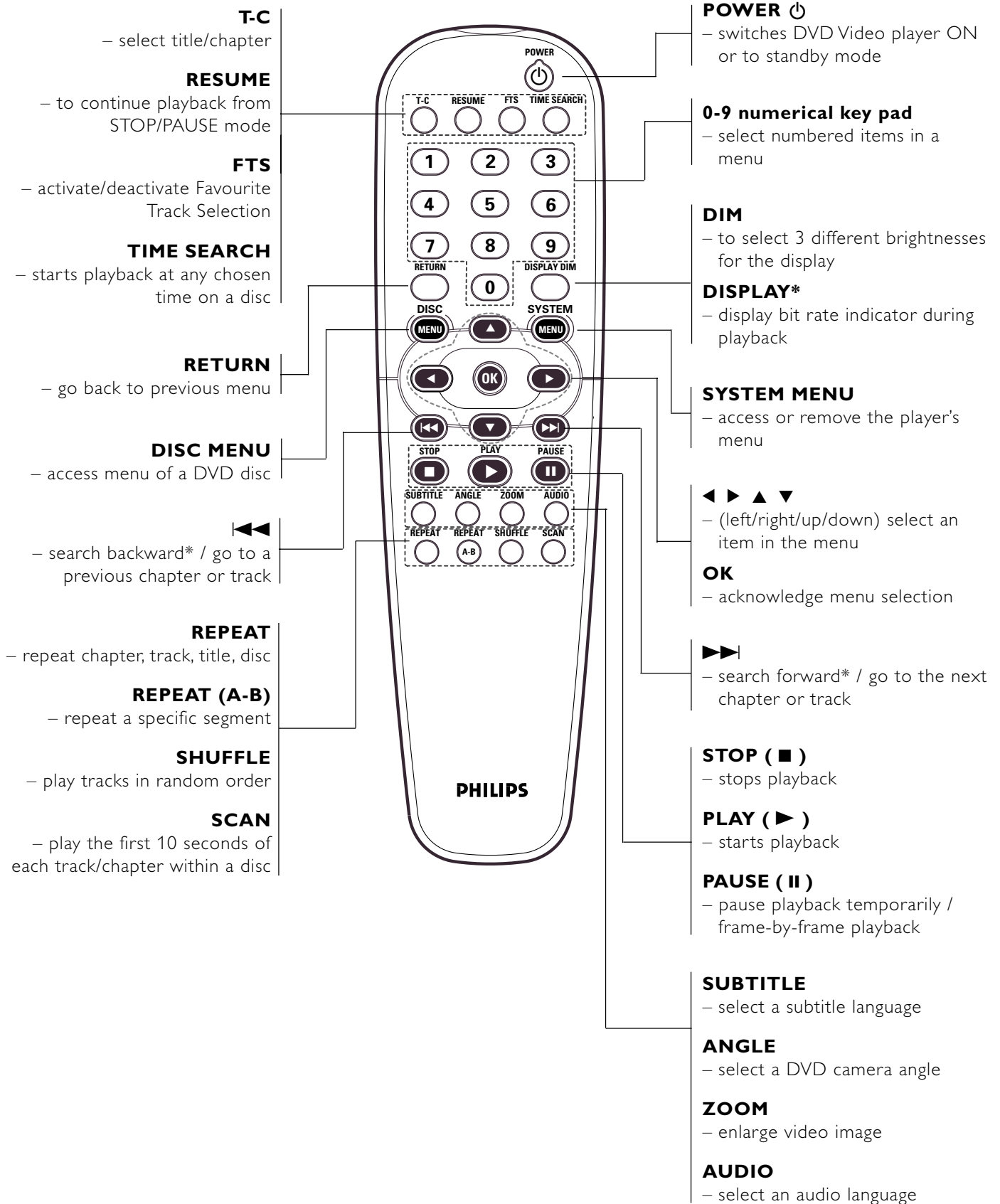

* Press and hold key for about two seconds

Preparation

General Notes

- Depending on your TV and other equipment you wish to connect, there are various ways you could connect the player. Use only one of the connections described below.
- Please refer to the manuals of your TV, VCR, Stereo System or other devices as necessary to make the best connections.
- For better sound reproduction, connect the player's audio out jacks to the audio in jacks of your amplifier, receiver, stereo or audio/video equipment. See 'Connecting to Optional Equipment'.

Caution:

- Make sure the DVD player is connected directly to the TV. Set the TV to the correct video input channel.
- Do not connect the player's audio out jack to the phono in jack of your audio system.
- Do not connect your DVD player to the TV via your VCR. The DVD image could be distorted by the copy protection system.

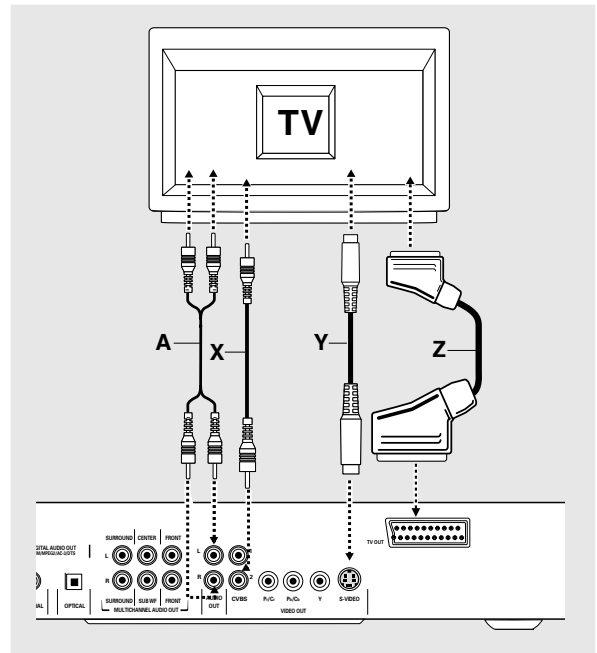

Connecting to a TV

- Make one of the following connections, depending on the capabilities of your existing equipment.

SCART connection

- 1 Connect the SCART to the corresponding connector on the TV using the SCART cable supplied (Z).

If your TV is not equipped with a SCART you can select one of the following alternative connections:

S-Video (Y/C) connection

- 1 Connect the Y/C S-VIDEO OUT jack on the DVD player to the S-Video in jack on the TV using an optional S-Video cable (Y).
- 2 Connect the Left and Right AUDIO OUT jacks of the DVD player to the audio left/right in jacks on the TV (A).

CVBS connection

- 1 Connect the (CVBS) VIDEO OUT jack on the DVD player to the video in jack on the TV using the video cable supplied (X).
- 2 Connect the Left and Right AUDIO OUT jacks of the DVD player to the audio left/right in jacks on the TV (A).

Component Video (Pr/Cr Pb/Cb Y) connection

- 1 Connect either S-Video or CVBS video out jack to TV as above diagram.
- 2 Turn on the TV and go to Personal Preference menu (see *Personal Preference*).
- 3 Select the video output from RGB (default) to Pr/Cr Pb/Cb Y.
- 4 Connect the Pr/Cr Pb/Cb Y VIDEO OUT jacks on the DVD player to the corresponding in jacks on the TV using an optional Pr/Cr Pb/Cb Y cable (W).
- 5 Connect the Left and Right AUDIO OUT jacks of the DVD player to the audio left/right in jacks on the TV (A).

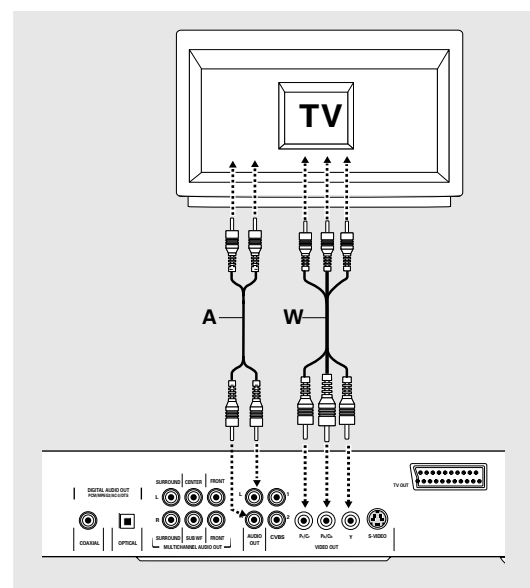

Connecting to Optional Equipment

Connecting to an amplifier equipped with two channel analog stereo or Dolby Surround

- 1 Connect the Left and Right audio out jacks of the DVD player to the audio left and right in jacks on your amplifier, receiver or stereo system, using the optional audio cable (A).

Note:

– You cannot use the MP3 function with the Digital Out connectors.

Connecting to an amplifier equipped with two channel digital stereo (PCM) or to an Audio/Video receiver equipped with a multi-channel decoder (Dolby Digital™, MPEG 2 and DTS)

- 1 Connect the player's digital audio out jack (optical G or coaxial F) to the corresponding in jack on your amplifier. Use an optional digital (optical G or coaxial F) audio cable.
- 2 You will need to activate the player's digital output (see 'Personal Preferences').

Digital Multi-channel sound

The digital multi-channel connection provides the best sound quality. For this you need a multi-channel A/V receiver that supports one or more of the audio formats supported by your DVD player (MPEG 2, Dolby Digital™ and DTS). Check the receiver manual and the logos on the front of the receiver:

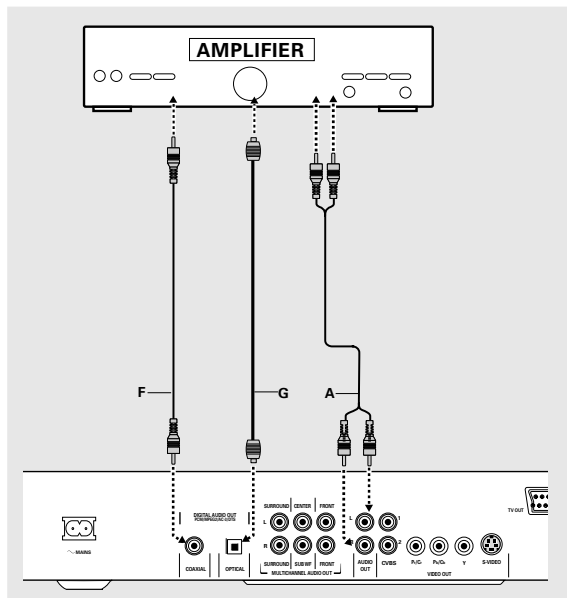

Warning:

Due to DTS Licencing agreement, the digital output will also be in DTS digital out when DTS audio stream is selected.

Note:

- If the audio format of the digital output does not match the capabilities of your receiver, the receiver will produce a strong, distorted sound or no sound at all.
- Six Channel Digital Surround Sound via digital connection can only be obtained if your receiver has a Digital Multi-channel decoder.
- To see the selected audio format of the current DVD in the Status Window, press SYSTEM MENU or Audio button.

Analog connection to a multi-channel A/V receiver with 6 CH connectors (Dolby Digital & DTS)

This DVD player contains a multi-channel decoder. This enables playback of DVDs recorded in Multi-channel Surround without the need for an optional decoder:

- 1 Connect the audio out jacks for Center speaker and Subwoofer connection (C) to the corresponding in jacks on your receiver.
- 2 Connect the audio Left and Right out jacks for Front speaker connection (B) to the corresponding in jack sockets on your receiver.
- 3 Connect the audio Left and Right out jacks for Surround speaker connection (D) to the corresponding in jacks on your receiver.
- 4 Make the appropriate Sound settings for Analog Output and Speaker Settings in the Personal Preferences menu.

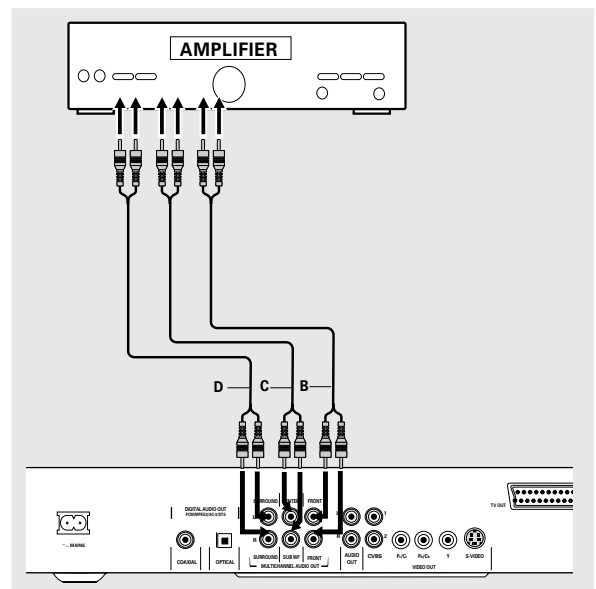

NTSC/PAL Settings

You can switch the NTSC/PAL setting of the DVD player to match the video signal of your TV. This setting only affects the television's on-screen display that shows the stop and setup modes. You may select either NTSC or PAL. To change the DVD player setting to PAL or NTSC, follow the steps below.

- 1 Unplug the DVD player from the mains.
- 2 Press and hold ■ and ►►I, on the front of the DVD player. While holding ■ and ►►I, plug in the mains.
- 3 After PAL or NTSC appears on the display of the DVD player, release ■ and ►►I at the same time. The PAL or NTSC indicator that appears on the display indicates the current setting.
- 4 To change the setting, press ►►I within three seconds. The new setting (PAL or NTSC) will appear on the display.

NTSC/PAL Conversion

This player is equipped with a NTSC/PAL conversion feature to convert the video output of the disc to match your TV system. The conversions supported are as below:

Type	Disc Format	Output format		
		Selected mode		
		NTSC	PAL	AUTO
DVD	NTSC	NTSC	PAL	NTSC
	PAL	Not Supported	PAL	PAL
VCD	NTSC	NTSC	PAL	NTSC
	PAL	NTSC	PAL	PAL

- 1 In the Preference Menu, select **TV System**.
- 2 Press ▲ or ▼ to select PAL, NTSC or AUTO.

Notes:

- *AUTO can only be selected when using a TV that has both the NTSC and PAL systems.*
- *This is applicable for CVBS output on cinch and SCART only*
- *Slight picture distortions may occur due to this conversion. This is normal. Thus, the AUTO format is most suitable for the best picture quality.*

General Explanation

About this manual

This manual gives the basic instructions for operating the DVD player. Some DVDs require specific operation or allow only limited operation during playback. When this occurs, the symbol ✕ appears on the TV screen, indicating that the operation is not permitted by the player or the disc.

Remote control operation

- Unless stated, all operations can be performed by the remote control. Always point the remote control directly at the player, making sure there are no obstructions between the remote and the player. Corresponding keys on the front panel of the player can also be used.

Menu bar operation

- A number of operations can be done with the menu bar on the screen. The menu bar icons can be accessed by pressing the cursor keys on the remote control.
- Pressing SYSTEM MENU while the menu bar is displayed will clear the menu bar from the screen.
- The selected item will be highlighted, and the appropriate cursor keys to operate it will be displayed below the icon.
- The symbols < or > indicate more items are available at the left/right of the menu bar: Press ◀ or ▶ to select these items.

Initial Setup (Virgin Mode)

General

In 'Initial Setup' you may have to set your preferences for some of the player's features. *(not applicable for all models)*

Operation

After switching on the player for the very first time, the 'Initial Setup Screen' will appear. The menu for the first item to be set is displayed and the first option is highlighted.

- Use the ▼ ▲ keys to go through the options in the menu. The icon of the selected option will be highlighted.
- Use OK to confirm your selection and to go to the next menu.

Note:

- Preferences have to be set in the order of which the item menus will appear on the screen.
- The 'Initial Setup' screen will only disappear after the settings for the last item have been confirmed.
- If any keys other than ▼ ▲ or OK are pressed, ✕ will appear on the screen.
- If the player is switched off while setting personal preferences, all preferences have to be set again after switching the player on again.

The following items may have to be set in Initial Setup:

Menu language

You can choose from different languages. The On Screen Menus will be displayed in the language available on the player.

Audio language

You can choose from different languages. If available on the disc, the player will play the audio in the selected language. If the selected language is not available, speech will revert to the first spoken language on the disc.

Subtitle language

You can choose from different subtitle languages. If available on the disc, subtitles will be in the language chosen. If the selected language is not available, subtitles will revert to the first subtitle language on the disc.

TV Shape

If you have a wide screen (16:9) TV, select 16:9.

If you have a regular (4:3) TV, select 4:3.

If you have a 4:3 TV, you can also select between:

Letterbox for a 'wide-screen' picture with black bars top and bottom, or Pan Scan, for a full-height picture with the sides trimmed. If a disc supports the format, the picture will be shown accordingly.

Country

Select your country. This is used as input for the 'Parental Control' feature (see 'Access Control').

Note:

- All these items may have to be set during 'Initial Setup'. After that, they can always be changed in the Personal Preferences Menu.

Display on Front Panel





Various icons will appear on the front panel display depending on the current status of the player.

	CDDA disc		Repeat
	DVD disc		Scan
	Error disc		Search backward
	Disc lock		Search forward
	MP3 disc		Setup
	SVCD disc		Shuffle
	VCD disc		Slow backward
	Info		Slow forward
	No disc		Stop
	Open		Action Prohibited
	Pause		Zoom
	Play		





Menu Bar on TV Screen

As there are multiple menu bars, the items on the menu bar are arranged according to usage and availability of direct access keys. Pressing the SYSTEM MENU keys repeatedly will toggle through menu bar 1, menu bar 2, menu bar 3 and OFF.





Menu bar 1

-  Personal Preferences
-  Subtitle Language
-  Audio Language
-  Colour Setting (Smart Picture)
-  Sound















Menu bar 2

-  Step by step playback
-  Slow motion
-  Fast motion
-  Angle
-  Zoom

Menu bar 3

-  Title
-  Chapter
-  Time Search
-  Favorite Track Selection (FTS)
-  Wake up Timer





Temporary Feedback Field Icons

-  Scan
-  Repeat All
-  Repeat Title
-  Repeat Track
-  Repeat Chapter
-  Shuffle
-  Shuffle Repeat
-  Repeat A to end
-  Repeat A-B
-  Angle
-  Child Lock On
-  Child Safe
-  Resume
-  Action prohibited

Personal Preferences

You can set your own personal preferences on the player.

General operation:

- Press SYSTEM MENU on the remote control.
- Select  in the menu bar.
→ The Personal Preferences menu appears.
- Use the     keys to toggle through the menus, submenus and submenu options.
→ When a menu item is selected, the cursor keys (on the remote control) to operate the item are displayed next to the item.
- Press OK to confirm and return to the main menu.
The following items can be adapted:

Picture

– TV Shape

If you have a wide screen (16:9) TV, select 16:9.

If you have a regular (4:3) TV, select 4:3.

If you have a 4:3 TV, you can also select between:

Letterbox for a 'wide-screen' picture with black bars at the top and bottom of the screen, or Pan Scan, for a full-height picture with the sides trimmed. If a disc supports the format, the picture will be shown accordingly.

– Black level shift (NTSC users only)

Select ON for adapting the Colour dynamics to obtain richer contrasts.

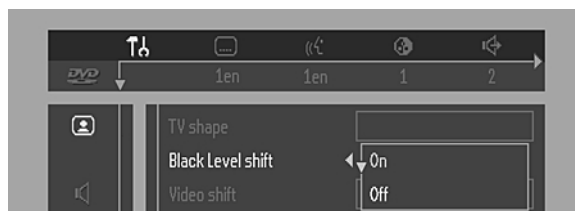

– Video shift

The factory centers the video on your TV screen. Use this setting to personalize the position of the picture on your TV by moving it to the left or right.

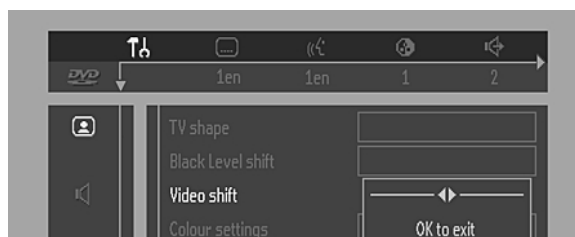

– Colour settings

You can select one of five predefined sets of colour settings and one set (Personal) which you can define yourself.

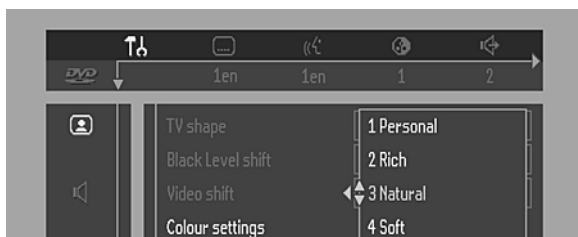

– Personal colour

Allows you to fine-tune the selected colour settings saturation, brightness and contrast.

– RGB/YUV switching (Video Output)

This setting allows you to toggle the output of the video signal between RGB(on scart) and Y PrCr PbCb (YUV).

Warning:

When the player is set to Y PrCr PbCb (YUV), some TV may not properly synchronise with player on the SCART connector.

– TV System

Allows you to select between PAL, NTSC and AUTO mode depending on your TV.

Note:

– Refer to “NTSC/PAL Conversion”.

Sound

– Digital output

Factory setting: ALL. This means coaxial and optical output is on. If you are not connecting to equipment with a digital input, change the setting to OFF.

If your equipment doesn't include a digital multi-channel decoder, set the digital output to PCM only (Pulse Code Modulation).

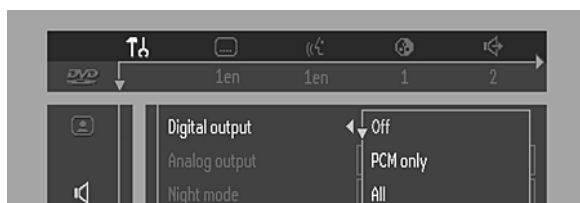

– Analog output

Select Stereo, Dolby Surround, 3D Sound (TruSurround) or multichannel output to match your system's playback capability.

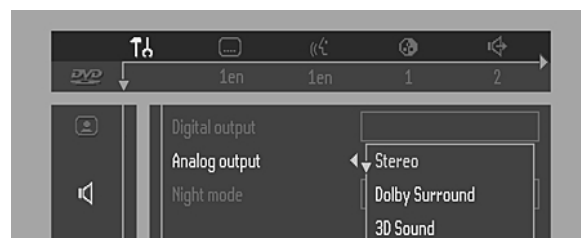

– Night Mode

Optimizes the dynamics of the sound for low volume playback.

– Speaker settings

Allows you to select speaker settings, volume balance and delay time and to test the speaker settings.

Speaker settings are only active on the Analog Multi-Channel Output. (See appendix)

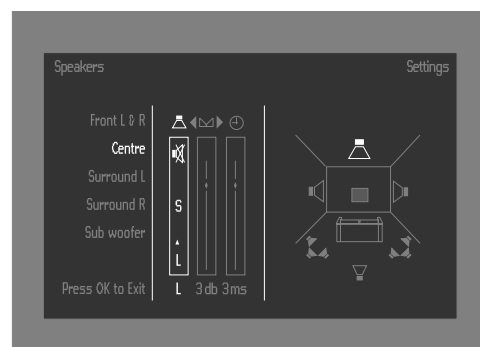

– PCM Output

Allows to select PCM digital output between 48kHz and 96kHz. When 48kHz has been selected, 96kHz (if available on disc) PCM data stream will be converted to 48kHz.

– Karaoke vocal

Put this setting to ON only when a multi-channel karaoke DVD is being played. The karaoke channels on the disc will then be mixed into a normal stereo sound.

Loading Discs

- 1 Press EJECT on the front of the player to open the disc tray.
- 2 Load your chosen disc in the tray, label side up.
- 3 Press EJECT again to close the tray.
→ **READY** appears in the status window and on the player display, and playback starts automatically.

Note:

– If 'Child Lock' is set to ON and the disc inserted is not authorized, the 4-digit code must be entered and/or the disc must be authorized (see 'Access Control').

Playing a DVD Video and Video CD

Playing a disc

- After inserting the disc and closing the tray, playback starts automatically. The status window of the player display shows the type of disc loaded.
- The disc may invite you to select an item from a menu. If the selections are numbered, press the appropriate numerical key; if not, use the **▼▲◀▶** keys to highlight your selection, then press **OK**.
- The number of the current title and chapter are displayed.
- Playback may stop at the end of the Title and you may return to the DVD disc menu. To go to the next title, press **▶**.
- To stop playback, press **■**.
→ The default screen will appear, giving information about the current status.
- You can resume playback from the point at which you stopped playback. Press **▶**; when you see the Resume icon **▶** on the screen, press **▶** again.
→ The RESUME feature applies not only to the disc in the player, but also to the last four discs you have played. Simply reload the disc and press **RESUME** on the remote control. Or, press **▶** when you see the Resume icon **▶** on the screen, then press **▶** again.



Note:

– DVDs may have a region code. Your player will not play discs that have a region code different from the region code of your player.

General Features

Note:

– Unless stated, all operations described are based on remote control use. Some operations can be carried out using the menu bar on the screen.

Moving to another title/ chapter

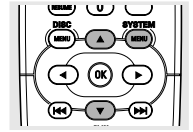

When a disc has more than one title or chapter, you can move to another title/chapter as follows:

- Press **SYSTEM MENU**, then select **T** or **C** in the menu bar.
- Press **▲** or **▼** to select a title/chapter.

Slow Motion

- Select **▶** (SLOW MOTION) in the menu bar.
- Use the **▼** keys to enter the SLOW MOTION menu.
→ Playback will pause.
- Use the cursor keys **◀▶** to select the required speed: -1, -1/2, -1/4 or -1/8 (backward), or +1/8, +1/4, +1/2 or +1 (forward).
- Select 1 to play the disc at normal speed again.
- If **||** is pressed, the speed will be set to zero (PAUSE).
- To exit slow motion mode, press **▶** or **▲**.

Still Picture and Frame-by-frame playback

- Select **▶** (STEP) in the menu bar.
- Use the **▼** key to enter the step by step menu.
→ Playback will pause.
- Use the cursor keys **◀▶** to select the previous or next picture frame.
- To exit step by step playback, press **▶** or **▲**.

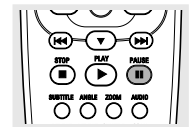

You can also step forward by pressing **||** repeatedly on the remote control.





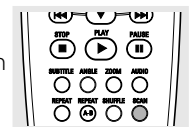

Scan

Scanning plays the first 10 seconds of each chapter/track on the disc.

- Press **SCAN**.
- To continue playback at your chosen chapter/track, press **SCAN** again or press **▶**.



Search

- Select  (FAST MOTION) in the menu bar.
- Use the  keys to enter the FAST MOTION menu.
- Use the   keys to select the required speed: -32, -8 or -4 (backward), or +4, +8, +32 (forward).
- Select 1 to play the disc at normal speed again.
- To exit FAST MOTION mode, press  or .

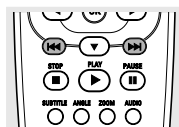

To search forward or backward through different speeds, you can also hold down   or  .



Repeat



DVD Video Discs

Repeat chapter/title/disc

- To repeat the current chapter, press REPEAT.
→  appears on the DVD player display.
- To repeat the current title, press REPEAT a second time.
→  appears on the DVD player display.
- To repeat the entire disc, press REPEAT a third time.
→  appears on the DVD player display.
- To exit Repeat mode, press REPEAT a fourth time.



Video CDs

Repeat track/disc

- To repeat the current track, press REPEAT.
→  appears on the DVD player display.
- To repeat the entire disc, press REPEAT a second time.
→  appears on the DVD player display.
- To exit Repeat mode, press REPEAT a third time.

Repeat A-B

To repeat a specific portion of a title:

- Press REPEAT A-B at your chosen starting point.
→  appears briefly on the DVD player display.
- Press REPEAT A-B again at your chosen end point.
→  appears briefly on the DVD player display, and the repeat sequence begins.
- To cancel the sequence and continue regular playback, press REPEAT A-B.

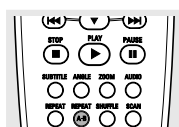

Shuffle

DVD Video discs

This shuffles the playing order of chapters within a title, if the title has more than one chapter:



- Press SHUFFLE during playback.
→ **SHUFFLE** appears on the TV screen for about two seconds.
- To return to normal playback, press SHUFFLE again.

Video CDs

- Press SHUFFLE during playback.
→ **SHUFFLE** appears on the TV screen for about two seconds.
- To return to normal playback, press SHUFFLE again.

Time search

The Time Search function allows you to start playing at any chosen time on the disc.

- Select  (TIME SEARCH) in the menu bar.
- Press .
→ Playback will pause.
→ A time edit box appears on the screen, showing the elapsed playing time of the current disc.
- Use the numeric keys to enter the required start time. Enter hours, minutes and seconds from left to right in the box.
→ Each time an item has been entered, the next item will be highlighted.
- Press OK to confirm the start time.
→ The time edit box will disappear and playback starts from the selected time on the disc.

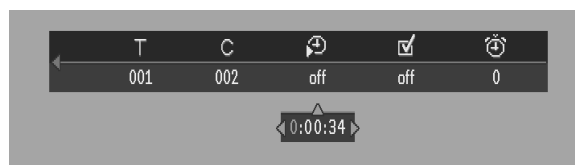

Special DVD Features

Checking the contents of DVD Video discs: Menus

DVDs may contain menus to navigate the disc and access special features. To use the menu, press the appropriate numerical key or use the \blacktriangledown , \blacktriangle , \blacktriangleright , \blacktriangleleft keys to highlight your selection, then press OK.

Title/Disc menu

- Press **DISC MENU**.
→ If the current title has a menu, the menu will appear on the screen. Otherwise, the disc menu will be displayed.
- The menu can list camera angles, spoken language and subtitle options, and chapters for the title.
- To remove the title menu, press **DISC MENU** again.

Camera Angle

If the disc contains sequences recorded from different camera angles, the angle icon appears, showing the number of available angles and the angle being shown currently. You can then change the camera angle if you wish.

- Use the \blacktriangle / \blacktriangledown keys to select the required angle.
→ After a while, playback changes to the selected angle. The angle icon remains displayed until multiple angles are no longer available.



Changing the audio language

- Select \llcorner (**AUDIO**) in the menu bar.
- Press **AUDIO** or \blacktriangle / \blacktriangledown repeatedly to see the different languages.



Subtitles

- Select \square (**SUBTITLE**) in the menu bar.
- Press **SUBTITLE** or \blacktriangle / \blacktriangledown repeatedly to see the different subtitles.



Special Video CD & SVCD Features

Playback Control (PBC)

- Load a Video CD with PBC and press \blacktriangleright .
- Go through the menu with the keys indicated on the TV screen until your chosen passage starts to play. If a **PBC** menu consists of a list of titles, you can select a title directly.
- Enter your choice with the numerical keys (0-9).
- Press RETURN to go back to the previous menu.
- You may also select **PBC OFF** under Personal Preferences.

Playing an Audio CD

- After loading the disc, playback starts automatically.
- If the TV is on, the Audio CD screen appears.
- The number of tracks and the total playing time of the disc will be shown on the TV screen.
- During playback, the current track number and its elapsed playing time will be shown on the TV screen and on the player display.
- Playback will stop at the end of the disc.
- To stop playback at any other time, press \blacksquare .

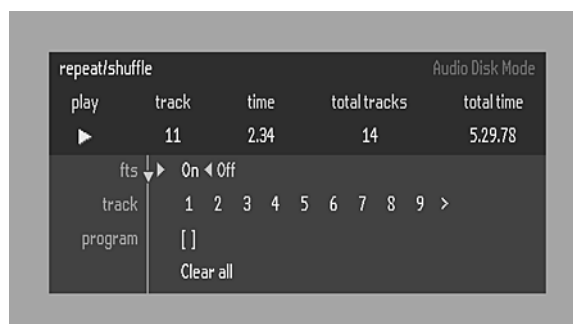

Pause

- Press II during playback.
- To return to playback, press \blacktriangleright .

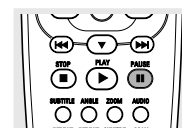

Search

- To search forward or backward through the disc at four times the normal speed, hold down $\text{L} \llcorner$ or $\text{R} \llcorner$ for about one second during playback.
→ Search begins, and sound is partially muted.
- To step up to eight times the normal speed, press $\text{L} \llcorner \llcorner$ or $\text{R} \llcorner \llcorner$ again.
→ Search goes to eight times the speed, and the sound is muted.
- To return to four times the normal speed, press $\text{L} \llcorner$ or $\text{R} \llcorner$ again.
- If the TV is on, search speed and direction are indicated on the screen each time $\text{L} \llcorner$ or $\text{R} \llcorner$ is pressed.
- To end the search, press \blacktriangleright to resume playback or press \blacksquare to stop playback.

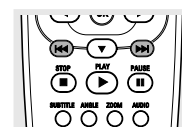

Moving to another track



- Press **◀◀** or **▶▶** briefly during playback to go to the next track or to return to the beginning of the current track.
- Press **◀◀** twice briefly to step back to the previous track.
- To go directly to any track, enter the track number using the numerical keys (0-9).

Shuffle

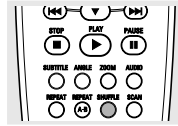
- Press **SHUFFLE** during playback.
→ The playing order of the tracks is changed.
- To return to normal playback, press **SHUFFLE** again.



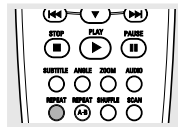

Repeat track/disc

- To repeat the current track, press REPEAT.
→  appears on the DVD player display.
- To repeat the entire disc, press REPEAT a second time.
→  appears on the DVD player display.
- To exit Repeat mode, press REPEAT a third time.



Repeat A-B

To repeat a specific portion of a track:

- Press REPEAT A-B at your chosen starting point.
→  appears on the DVD player display.
- Press REPEAT A-B again at your chosen end point.
→  appears on the DVD player display, and the sequence begins to play repeatedly.
- To cancel the sequence and continue playback, press REPEAT A-B.

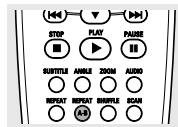

Scan

Scanning plays the first 10 seconds of each track on the disc.

- Press **SCAN**.
- To continue playback at your chosen track, press **SCAN** again or press **▶**.

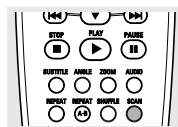

Favorite Track Selection (FTS) Program

- The FTS Program allows you to store your favorite tracks for a particular disc in the player memory.
- Each FTS Program can contain 20 tracks.

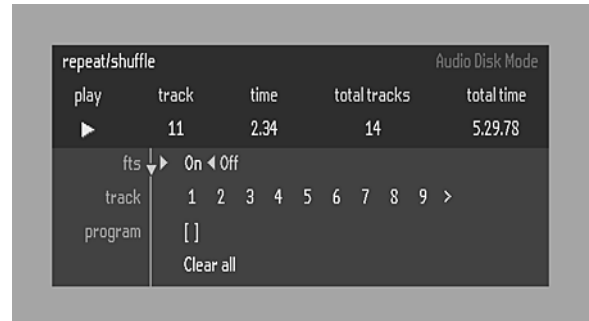

Storing an FTS Program

- 1 Load a disc and stop playback.
- 2 Use **▼** to go to the list of available tracks.
- 3 Use **▶** or **◀** to select tracks from the list.
To go directly to any track, enter the track number using the numerical keys (0-9).
- 4 Store each track by pressing OK.
→ The track numbers will be added to the list.
→ The number of tracks and the playing time of the program will be shown on the TV screen and the player display.

When your FTS Program is complete, press **▶** to start playback or; press **▲** to go back to Stop mode. In either case, the FTS Program will be automatically memorized.

Switching FTS ON/OFF

- 1 Use **▲▼** to select FTS.
- 2 Use **▶** or **◀** to select either ON or OFF.

Erasing a track from an FTS Program

- 1 Use **▼** to go to the list of selected tracks.
- 2 Use **▶** and **◀** to select the track number you wish to erase.
- 3 Press OK.
→ The track number will be erased from the list of selected tracks.

Erasing the complete program

- 1 Use **▼** to select **CLEAR ALL**, then press OK.
→ The complete FTS Program for the disc will be erased.

MP3 Disc Features *(for specific version only)*

Support following MP3-CD formats (ISO9660 format):

- Max. 30 characters
- Max. nested directory is 8 levels
- The max. ALB number is 32
- Supported VBR bit-rate
- Supported sampling frequencies for MP3 disc are: 32 kHz, 44.1 kHz, 48 kHz
- Supported Bit-rates of MP3 disc are: 32, 64, 96, 128, 192, 256 (kbps)

Following formats can't be supported

- The files like *.WMA, *.AAC, *.DLF, *.M3U, *.PLS
- Chinese filenames
- The non-session closed discs
- The discs recorded under UDF format

Downloading MP3 files from the Internet or copying songs from your own legal discs is a delicate process.

Sound Quality	Bit Rate	Approximate Reduction Ratio	Approximate total MP3-CD time	Comment
AM radio	32 kbps	40 : 1	40 hrs	Sound quality significantly affected - not recommended.
FM radio	64 kbps	20 : 1	20 hrs	
Near-CD	96 kbps	15 : 1	15 hrs	Balanced sound quality - compression rate
CD-like	128 kbps	10 : 1	10 hrs	
CD*	256 kbps	5 : 1	5 hrs	Compression rate low - suggest to play CDs instead
CD*	320 kbps	3 : 1	3 hrs	

You may experience an occasional “skip” while listening to your MP3 files. This is normal.

Additional note for MP3 disc Playback:

- In compliance with the SDMI, digital-out is muted while playing MP3 discs.
- Due to the recording nature of Digital Audio MP3 (DAM), only Digital Audio music will play.
- The disc reading time may exceed 10 seconds due to the large number of songs compiled onto one disc.
- Only the first session of multisession discs is supported.

Album/Title

This feature allows you to view and select the next or previous MP3 disc Album/Title.

- 1 Press ▲/▼ to scroll through the previous or next Album.
- 2 Press ◀▶ to scroll through the previous or next Track.
- 3 You can also select the desired album/track number directly using the numeric keys on the remote control.

Note:

- **In STOP mode:** numbers are used for ALBUM selection.
- **In PLAY mode:** numbers are used for TRACK selection.

MP3 - Audio Mode			
play	album	track	time
▶	11	42	2.34
total albums		total tracks	
28		43	

- Only the following functions are possible for MP3 discs:
 - STOP / PLAY / PAUSE
 - SKIP NEXT / PREVIOUS
 - REPEAT (TRACK / ALBUM / DISC)

MP3 Discs - Album/Track/Disc

- To repeat a track, press REPEAT.
 - **REPEAT TRACK** appears on the TV screen.
- To repeat an album, press REPEAT a second time.
 - **REPEAT ALBUM** appears on the TV screen.
- To repeat the entire disc, press REPEAT a third time.
 - **REPEAT DISC** appears on the TV screen.
- To exit REPEAT mode, press REPEAT a fourth time.
 - **REPEAT OFF** appears on the TV screen.

Access Control: Child Lock (DVD Video and Video CD)

Activating/deactivating the Child Lock

- 1 When disc playback is stopped, select **ACCESS CONTROL** in the features menu using the ▲/▼ keys.
- 2 Enter a 4-digit code of your own choice.
- 3 Enter the code a second time.
- 4 Move to **"CHILD LOCK"** using the ▲/▼ keys.
- 5 Move to **LOCK/UNLOCK** using the ► key.
- 6 Select **LOCK** using the ▲/▼ keys.
- 7 Press OK or ◀ to confirm, then press ◀ again to exit the menu.
→ Now unauthorized discs will not be played unless the 4-digit code is entered.
- 8 Select **UNLOCK** to deactivate the **CHILD LOCK**.

Note: Confirmation of the 4-digit code is necessary when:

- The code is entered for the very first time (see above),
- The code is changed (see 'Changing the 4-digit code'),
- The code is cancelled (see 'Changing the 4-digit code').

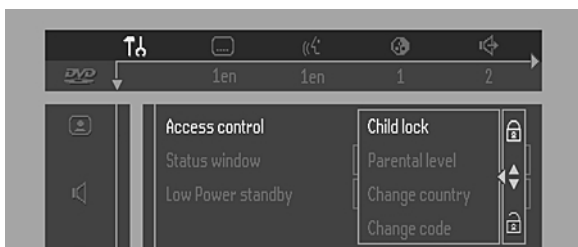

Authorizing discs

- Insert the disc. See 'Loading discs'.
→ The 'child protect' dialog will appear.
You will be asked to enter your secret code for 'Playback Once' or 'Playback Always'. If you select 'Playback Once', the disc can be played as long as it is in the player and the player is ON. If you select 'Playback Always', the disc will become child safe (authorized) and can always be played, even if the Child Lock is set to ON.

Notes:

- The player memory maintains a list of 120 authorized ('Child safe') disc titles. A disc will be placed in the list when 'Playback Always' is selected in the 'child protect' dialog.
- Each time a 'child safe' disc is played, it will be placed on top of the list. When the list is full and a new disc is added, the last disc in the list will be removed from the list.
- Double-sided DVDs may have a different ID for each side. In order to make the disc 'child safe', each side has to be authorized.
- Multi-volume VCDs may have a different ID for each volume. In order to make the complete set 'child safe', each volume has to be authorized.

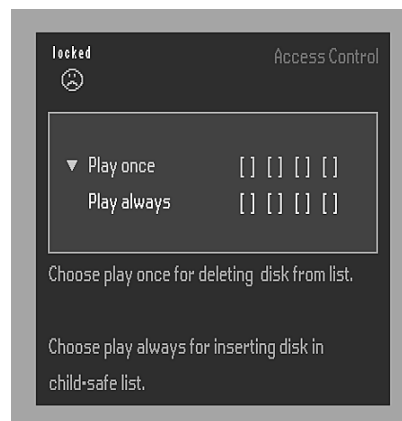

Deauthorizing discs

- Insert the disc. See 'Loading discs'.
→ Playback starts automatically.
- Press ■ while ☺ is visible.
→ The ☹ will appear and the disc is now deauthorized.

Access Control: Parental Control (DVD Video only)

Movies on DVDs may contain scenes not suitable for children. Therefore, discs may contain 'Parental Control' information which applies to the complete disc or to certain scenes on the disc. These scenes are rated from 1 to 8, and alternative, more suitable scenes are available on the disc. Ratings are country dependent. The 'Parental Control' feature allows you to prevent discs from being played by your children or to have certain discs played with alternative scenes.

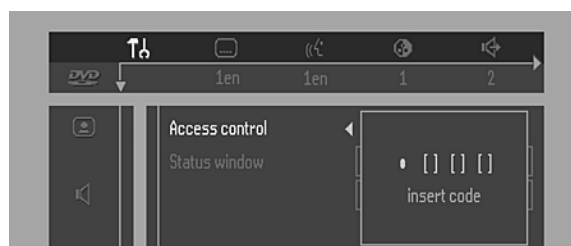

Activating/Deactivating Parental Control

- 1 When disc playback is stopped, select **ACCESS CONTROL** in the features menu using the ▲/▼ keys.
- 2 Enter your 4-digit code. If necessary, enter the code a second time.
- 3 Move to **Parental Control** using the ▲/▼ keys.
- 4 Move to **VALUE ADJUSTMENT** (1-8) using the ► key.
- 5 Then use the ▲/▼ keys or the numerical keys on the remote control to select a rating from 1 to 8 for the disc inserted.

Rating 0 (displayed as ‘-’):

Parental Control is not activated. The Disc will be played in full.

Ratings 1 to 8:

The disc contains scenes not suitable for children. If you set a rating for the player, all scenes with the same rating or lower will be played. Higher rated scenes will not be played unless an alternative is available on the disc. The alternative must have the same rating or a lower one. If no suitable alternative is found, playback will stop and the 4-digit code has to be entered.

- 6 Press OK or ◀ to confirm, then press ◀ again to exit the menu.

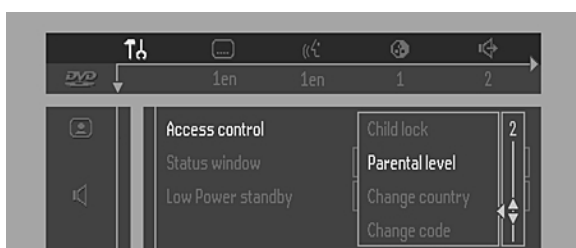

Country

- 1 When disc playback is stopped, select **ACCESS CONTROL** in the features menu using the ▲/▼ keys.
- 2 Enter the 4-digit code.
- 3 Move to **CHANGE COUNTRY** using the ▼ key.
- 4 Press the ► key.
- 5 Select a country using ▲/▼.
- 6 Press OK or ◀ to confirm, then press ◀ again to exit the menu.

Changing the 4-digit code

- 1 When disc playback is stopped, select **ACCESS CONTROL** in the features menu using the ▲/▼ keys.
- 2 Enter the old code.
- 3 Move to **CHANGE CODE** using the ▼ key.
- 4 Press the ► key.
- 5 Enter the new 4-digit code.
- 6 Enter the code a second time and reconfirm by pressing OK.
- 7 Press ◀ to exit the menu.

If you forget your 4 digit code

- 1 Press ■ to exit the 'Child Protect' screen.
- 2 Select **ACCESS CONTROL** in the features menu using the ▲/▼ keys.
- 3 Move to **ENTER CODE** using the ► key.
- 4 The 4-digit code can be cancelled by pressing ■ four times in the 'Access Control-Enter Code' dialog.
- 5 You can then enter a new code (twice!) as described above (Changing the 4 digit code).

Parental Control Disclaimer

This DVD player features the **PARENTAL CONTROL** system which is intended to activate when playing DVD discs furnished with certain software coding. This is according to technical standards adopted by the set maker and disc content industries.

Please note that the **PARENTAL CONTROL** system will not operate a DVD disc which is not furnished with the appropriate software coding. Also note that at the time of release of this DVD player, certain aspects of the technical standards had not been settled between set makers and the disc industries.

On this basis, Philips cannot guarantee the functioning of the **PARENTAL CONTROL** system and denies any liability associated with unintended watching of disc content.

If in doubt, please make sure the disc plays according to your **PARENTAL CONTROL** settings before you allow children access to the player.

Before Requesting Service

If it appears that the DVD Video player is faulty, first consult this checklist. Something may have been overlooked. Under no circumstances should you attempt to repair the system yourself; this will invalidate the warranty.

Look for the specific symptom(s). Then perform only the actions listed to remedy the specific symptom(s).

Symptom	Remedy
No power	<ul style="list-style-type: none">– Make sure the power cord is properly connected.– Check if there is power at the AC outlet by plugging in another appliance.
No picture	<ul style="list-style-type: none">– Check if the TV is switched on.– Check the video connection.
Distorted picture	<ul style="list-style-type: none">– Check the disc for fingerprints and clean the disc with a soft cloth, wiping from the centre to the edge in a straight line.– Sometimes a small amount of picture distortion may appear. This is not a malfunction.
Completely distorted picture or no colour with player menu	<ul style="list-style-type: none">– If the picture is distorted completely or if the picture rolls vertically, make sure the NTSC/PAL setting at the DVD player matches the video signal of your television.– If your TV video signal is NTSC, select the NTSC setting at the DVD player.– If your video signal is PAL, select the PAL setting. - See NTSC/PAL SETTINGS.– Check video output option in Personal Preferences is matching with actual connection.
Distorted or black/white picture with DVD or Video CD	<ul style="list-style-type: none">– The disc format does not match your TV's video signal (PAL/NTSC).– If your video signal is PAL, see NTSC/PAL Conversion.
No sound	<ul style="list-style-type: none">– Check audio connections.– If you are using a HiFi amplifier, try another sound source.
Distorted sound from HiFi amplifier	<ul style="list-style-type: none">– Check to make sure that no audio connections are made to the amplifier's phono input.
No audio at digital output	<ul style="list-style-type: none">– Check the digital connections.– Check the settings menu to make sure the digital output is set to ALL or PCM.– Check if the audio format of the selected audio language matches your receiver capabilities.– Not applicable for MP3
Disc can't be played	<ul style="list-style-type: none">– Ensure the disc label is facing up.– Clean the disc.– Check if the disc is defective by trying another disc.– Check to see if the disc is defective, badly scratched or warped (not flat).
No return to start-up screen when disc is removed	<ul style="list-style-type: none">– Reset the unit by switching the player off, then on again.– Check to see if the programme requires another disc to be loaded.
The player does not respond to the remote control	<ul style="list-style-type: none">– Aim the remote control directly at the sensor on the front of the player.– Remove any obstacles between the player and the remote control.– Inspect or replace the batteries in the remote control.
Buttons do not work	<ul style="list-style-type: none">– In order to completely reset the player, unplug the AC cord from the AC outlet. (Please ensure that the set is not in Initial Setup mode.)
Player does not respond to some operating commands during playback	<ul style="list-style-type: none">– Operations may not be permitted by the disc. Refer to the instructions of the disc.
DVD Video player cannot read CDs/DVDs	<ul style="list-style-type: none">– Use a commonly available cleaning CD/DVD to clean the lens before sending the DVD Video player for repair.

Speaker Settings

6 Channel settings

Front speaker

- L (Large): When the front speakers can reproduce low frequency signals below 120Hz
- S (Small): When the front speakers cannot produce low frequency signals below 120Hz

Center Speaker

- L (Large): When the center speaker can reproduce low frequency signals below 120Hz
- S (Small): When the center speaker cannot produce low frequency signals below 120Hz
- Off: When the center speaker is not connected

Surround speakers

- L (Large): When the surround speakers can reproduce low frequency signals below 120Hz
- S (Small): When the surround speakers cannot produce low frequency signals below 120Hz
- Off: When the surround speakers are not connected

Subwoofer

- On: When you connect a subwoofer
- Off: When a subwoofer is not connected

Note:

– Certain speaker settings are prohibited by the Dolby Digital licensing agreement.

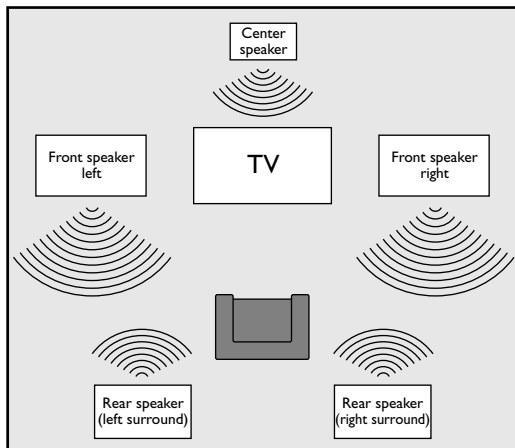

Delay times

The DVD player is set to reproduce correctly synchronized Digital Surround Sound in a listening area where the surround speakers are about 150cm nearer to the listening position than the front speakers, and the center speaker is in line with the front speakers. To adjust for other listening area arrangements, adapt delay times according to the following instructions:

Digital Surround

Measure the distances in centimeters from the front speaker and the surround speaker to the listening positioning. Subtract the surround distance from the front distance and divide by 30. The result is the required Surround Channel delay time in milliseconds. If the center speaker is in line with the front speaker, no center speaker delay is needed. If, however, it is nearer the listening position, measure the distance in centimeters between the front and center speaker planes, and divide by 30. The result is the required Center Channel delay time in milliseconds.

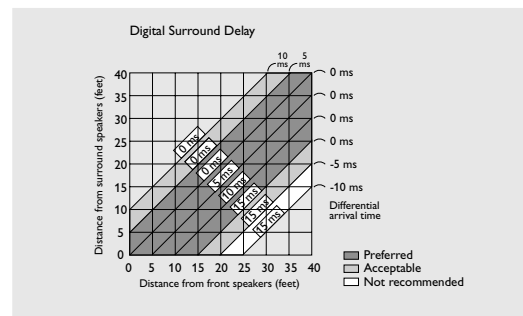

Specifications

PLAYBACK SYSTEM

DVD Video
Video CD & SVCD
CD (CD-Recordable and CD-Rewritable)
DVD+RW
MP3

OPTICAL READOUT SYSTEM

Lasertype Semiconductor AlGaAs
Numerical Aperture 0.60 (DVD)
0.45 (VCD/CD)
Wavelength 650 nm (DVD)
780 nm (VCD/CD)

DVD DISC FORMAT

Medium Optical Disc
Diameter 12cm (8cm)
Playing time 2.15 h*
(12cm) Dual layer 4 h*
Two side 4.30 h*
Single layer
Two side 8 h*
Dual layer

VIDEO FORMAT

DA Converter 10 bits
Signal handling Components
Digital Compression MPEG2 for DVD,
MPEG1 for VCD

TV STANDARD

	(PAL/50Hz)	(NTSC/60Hz)
Number of lines	625	525
Playback	Multistandard	(PAL/NTSC)

DVD

Horizontal Resolution	720 pixels	720 pixels
Vertical Resolution	576 lines	480 lines

VCD

Horizontal Resolution	352 pixels	352 pixels
Vertical Resolution	288 lines	240 lines

VIDEO PERFORMANCE

Video output 1Vpp into 75 ohm
S-Video output Y: 1 Vpp into 75 ohm
C: 0.3 Vpp into 75 ohm
Component video output Y: 1 Vpp into 75 ohm
Pb/Cb Pr/Cr: 0.7 Vpp into 75 ohm
RGB (SCART) output 0.7 Vpp into 75 ohm
Black Level Shift On/Off
Video Shift Left/Right

AUDIO FORMAT

Digital	MPEG	Compressed Digital
	DTS/Dolby Digital	
	PCM	16, 20, 24 bits fs, 44.1, 48, 96 kHz
MPEG MP3		MPEG Audio L3

Analog Sound Stereo
Dolby Pro Logic downmix from Dolby Digital multi-channel sound
Full decoding of Dolby Digital and DTS multi-channel surround sound
3D Sound (TruSurround) for virtual 5.1 channel sound on 2 speakers

AUDIO PERFORMANCE

DA Converter	24 bits	
DVD	fs 96 kHz	4 Hz - 44 kHz
	fs 48 kHz	4 Hz - 22 kHz
Video CD	fs 44.1 kHz	4 Hz - 20 kHz
	fs 44.1 kHz	4 Hz - 20 kHz
Signal-Noise (1kHz)		100 dB
Dynamic Range (1kHz)		97 dB
Crosstalk (1kHz)		110 dB
Distortion and Noise (1kHz)		88 dB

CONNECTIONS

SCART	Euroconnector
Y Output	Cinch (green)
Pb/Cb Output	Cinch (blue)
Pr/Cr Output	Cinch (red)
S-Video Output	Mini DIN, 4 pins
Video Output	Cinch (yellow)
Audio L+R output	Cinch (white/red)
6 Channel Analog Output	
Audio Front Left/Right	Cinch (white/red)
Audio Surround Left/Right	Cinch (white/red)
Audio Centre	Cinch (blue)
Audio Subwoofer	Cinch (black)
Digital Output	1 coaxial, 1 optical IEC958 for CDDA / LPCM IEC1937 for MPEG1/2, Dolby Digital and DTS

CABINET

Dimensions (w x h x d)	435 x 72.5 x 291 mm
Weight	Approximately 2.75 Kg

GENERAL FUNCTIONALITY

Stop / Play / Pause
Fast Forward / Backward
Time Search
Step Forward / Backward
Slow Motion
Title / Chapter / Track Select
Skip Next / Previous
Repeat (Chapter / Title / All) or (Track / All)
A-B Repeat
Shuffle
Scan
New enhanced user graphical interface
Perfect Still with digital multi-tap filter
Zoom (x1.33, x2, x4) with picture enhancement
Smart Picture for convenient personal Colour setting
NTSC/PAL Conversion
Screen Saver (Dim 75% after 15 minutes)
5.1 channels user defines speaker settings
3D Sound (TruSurround)
Virtual Jog Shuttle
Audio and video bit rate indicator
Display Dim
Beeper
Wake up Timer
PCM/Video Output

DVD FUNCTIONALITY

Multi-angle Selection
Audio Selection (one out of maximum eight languages)
Subtitles Selection (one out of maximum 32 languages)
Aspect Ratio conversion (16:9, 4:3 Letterbox, 4:3 Pan Scan)
Parental Control and Child Lock
Disc Menu support (Title Menu and Access Control)
Resume (5 discs) after stop / standby
Programming Titles/chapters with Favorite Track Selection

VIDEO CD FUNCTIONALITY

Playback Control for VCD 2.0 discs
Child Lock
Resume (5 discs) after stop / standby
Programming Tracks with Favorite Track Selection

AUDIO CD FUNCTIONALITY

Time Display (Total / Track / Remaining Track Time)
Full audio functionality with remote control
Programming with Favorite Track Selection

MP3 FUNCTIONALITY

Time Display (Track)
Album and Track Selection
Repeat (Disc / Album / Track)

* typical playing time for movie with 2 spoken languages and 3 subtitle languages

Specifications subject to change without prior notice